

**TrenchMOS/ Schottky diode array  
Three phase brushless d.c. motor driver**

**PHN603S**

**FEATURES**

- Schottky diode across each MOSFET
- Low on-state resistance
- Fast switching
- Logic level compatible
- Surface mount package

**SYMBOL**

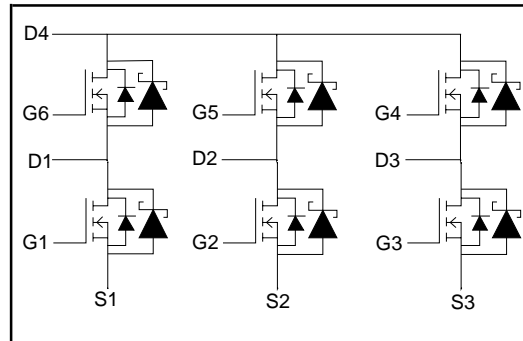

**QUICK REFERENCE DATA**

$V_{DS} = 25\text{ V}$
$I_D = 5.5\text{ A}$
$R_{DS(ON)} \leq 35\text{ m}\Omega (V_{GS} = 10\text{ V})$
$R_{DS(ON)} \leq 55\text{ m}\Omega (V_{GS} = 4.5\text{ V})$

**GENERAL DESCRIPTION**

Six n-channel, enhancement mode, logic level, field-effect power transistors and six schottky diodes configured as three half-bridges. This device has low on-state resistance and fast switching. The intended application is in computer disk and tape drives as a three phase brushless d.c. motor driver.

The PHN603S is supplied in the SOT137-1 (SO24) surface mounting package.

**PINNING**

PIN	DESCRIPTION
1,4	drain 1
2	source 1
3	gate 1
5,8	drain 2
6	source 2
7	gate 2
9,12	drain 3
10	source 3
11	gate 3
13	gate 4
14-16, 18-20, 22-24	drain 4
17	gate 5
21	gate 6

**SOT137-1 (SO24)**

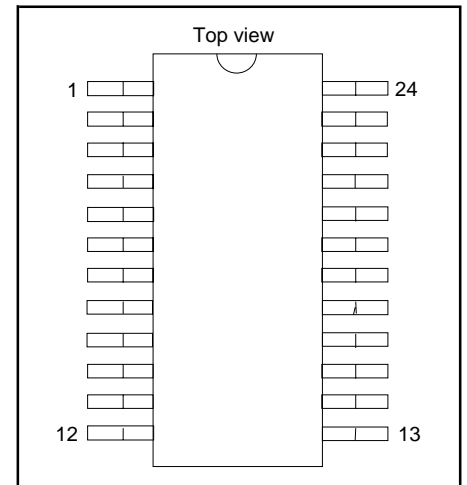

**LIMITING VALUES**

Limiting values in accordance with the Absolute Maximum System (IEC 134)

SYMBOL	PARAMETER	CONDITIONS	MIN.	MAX.	UNIT
$V_{DS}$	Repetitive peak drain-source voltage	$T_j = 25\text{ }^\circ\text{C}$ to $150\text{ }^\circ\text{C}$	-	25	V
$V_{DS}$	Continuous drain-source voltage	$T_j \leq 80\text{ }^\circ\text{C}^1$	-	25	V
$V_{DGR}$	Drain-gate voltage	$R_{GS} = 20\text{ k}\Omega$	-	25	V
$V_{GS}$	Gate-source voltage		-	$\pm 20$	V
$I_D$	Drain current per device (DC)	$T_a = 25\text{ }^\circ\text{C}$	-	5.5	A
		$T_a = 100\text{ }^\circ\text{C}$	-	3.5	A
$I_{DM}$	Drain current per device (pulse peak value)	$T_a = 25\text{ }^\circ\text{C}$	-	22	A
$P_{tot}$	Total power dissipation per device	$T_a = 25\text{ }^\circ\text{C}$	-	1.67	W
		$T_a = 100\text{ }^\circ\text{C}$	-	0.67	W
$P_{tot}$	Total power dissipation all devices conducting	$T_a = 25\text{ }^\circ\text{C}$	-	2.78	W
		$T_a = 100\text{ }^\circ\text{C}$	-	1.11	W
$T_{stg}, T_j$	Storage & operating temperature		- 55	150	$^\circ\text{C}$

<sup>1</sup> The maximum permissible junction temperature prior to application of continuous drain-source voltage is limited by thermal runaway.

## TrenchMOS/ Schottky diode array Three phase brushless d.c. motor driver

PHN603S

### THERMAL RESISTANCES

SYMBOL	PARAMETER	CONDITIONS	TYP.	MAX.	UNIT
$R_{th\ j-a}$	Thermal resistance junction to ambient	FR4 board, minimum footprint			
		Per device	75	-	K/W
		All devices conducting	42	-	K/W

### ELECTRICAL CHARACTERISTICS

 $T_j = 25^\circ\text{C}$  unless otherwise specified

SYMBOL	PARAMETER	CONDITIONS	MIN.	TYP.	MAX.	UNIT
$V_{(BR)DSS}$	Drain-source breakdown voltage	$V_{GS} = 0\text{ V}; I_D = 1\text{ mA}$	25	-	-	V
$V_{GS(TO)}$	Gate threshold voltage	$V_{DS} = V_{GS}; I_D = 1\text{ mA}$	1.0	1.8	-	V
$R_{DS(ON)}$	Drain-source on-state resistance	$T_j = 150^\circ\text{C}$ $V_{GS} = 10\text{ V}; I_D = 5\text{ A}$ $V_{GS} = 4.5\text{ V}; I_D = 2.5\text{ A}$ $V_{GS} = 10\text{ V}; I_D = 5\text{ A}; T_j = 150^\circ\text{C}$	-	30	35	m $\Omega$
$I_{GSS}$	Gate source leakage current	$V_{GS} = \pm 20\text{ V}; V_{DS} = 0\text{ V}$	-	10	100	nA
$I_{DSS}$	Zero gate voltage drain current	$V_{DS} = 25\text{ V}; V_{GS} = 0\text{ V}; T_j = 100^\circ\text{C}$	-	0.2	1.0	mA
$Q_{g(tot)}$	Total gate charge	$I_D = 1\text{ A}; V_{DD} = 20\text{ V}; V_{GS} = 10\text{ V}$	-	17	-	nC
$Q_{gs}$	Gate-source charge		-	1.7	-	nC
$Q_{gd}$	Gate-drain (Miller) charge		-	5.2	-	nC
$t_{don}$	Turn-on delay time	$V_{DD} = 20\text{ V}; I_D = 1\text{ A};$	-	8	-	ns
$t_r$	Turn-on rise time	$V_{GS} = 10\text{ V}; R_G = 6\ \Omega$	-	11	-	ns
$t_{doff}$	Turn-off delay time	Resistive load	-	31	-	ns
$t_f$	Turn-off fall time		-	17	-	ns
$C_{iss}$	Input capacitance	$V_{GS} = 0\text{ V}; V_{DS} = 20\text{ V}; f = 1\text{ MHz}$	-	650	-	pF
$C_{oss}$	Output capacitance		-	320	-	pF
$C_{rss}$	Feedback capacitance		-	130	-	pF

### SCHOTTKY DIODE LIMITING VALUES AND CHARACTERISTICS

 $T_j = 25^\circ\text{C}$  unless otherwise specified

SYMBOL	PARAMETER	CONDITIONS	MIN.	TYP.	MAX.	UNIT
$I_F$	Continuous forward diode current	$T_a = 25^\circ\text{C}$	-	-	5.5	A
$I_{FRM}$	Repetitive peak forward diode current		-	-	22	A
$V_F$	Diode forward voltage	$I_F = 2.5\text{ A}; V_{GS} = 0\text{ V}$	-	0.4	0.6	V
		$I_F = 2.5\text{ A}; V_{GS} = 0\text{ V}; T_j = 100^\circ\text{C}$	-	0.3	0.55	V
$t_{rr}$	Reverse recovery time	$I_F = 0.5\text{ A to } I_R = 0.5\text{ A}$	-	20	-	ns

TrenchMOS/ Schottky diode array  
Three phase brushless d.c. motor driver

PHN603S

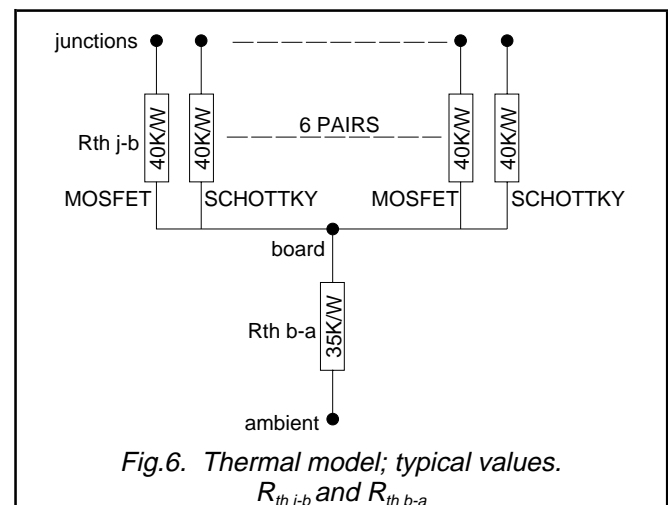
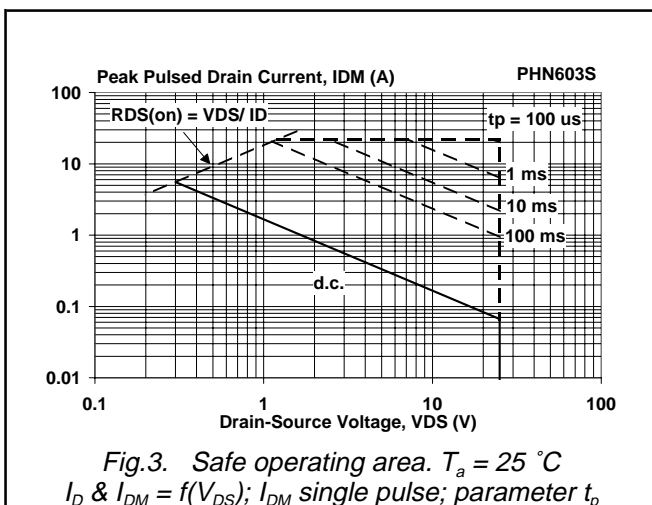
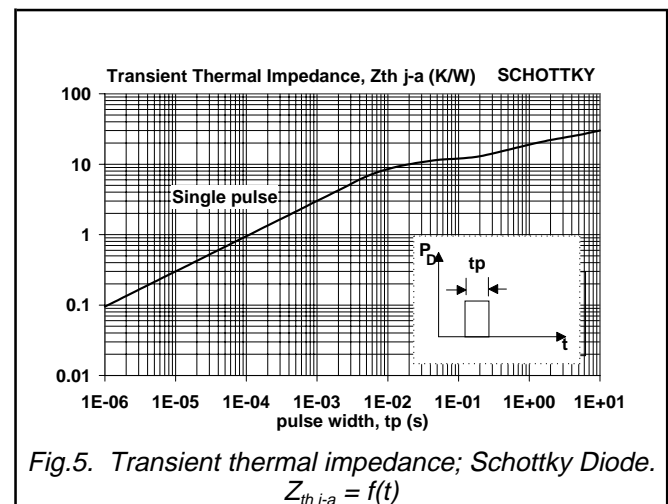
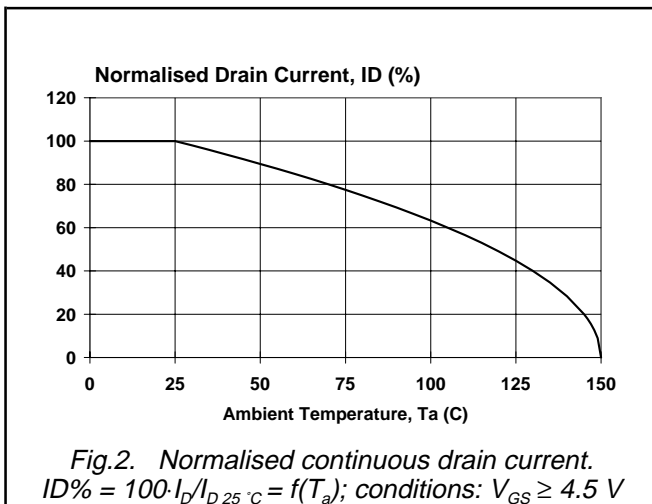
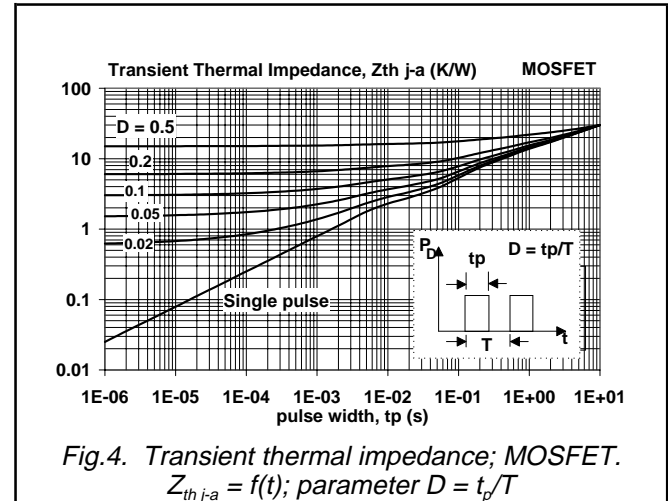
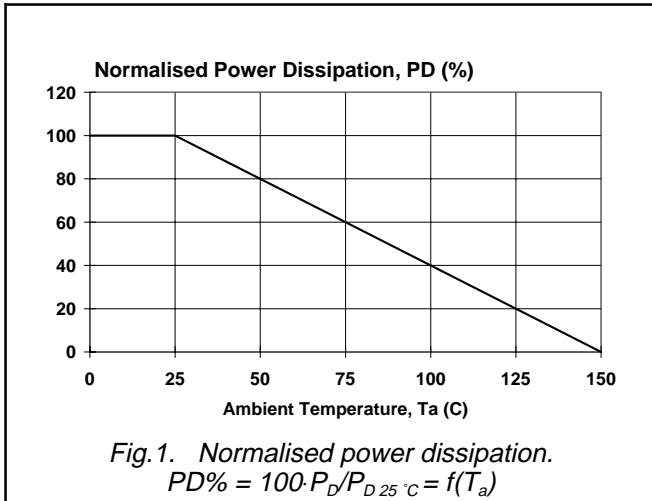

TrenchMOS/ Schottky diode array  
Three phase brushless d.c. motor driver

PHN603S

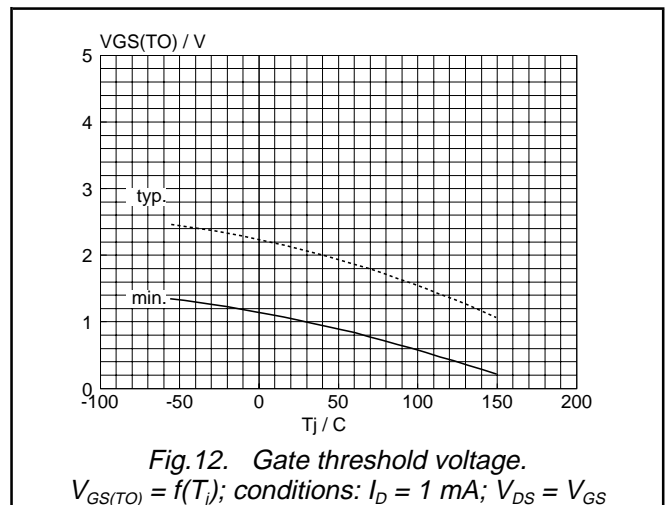
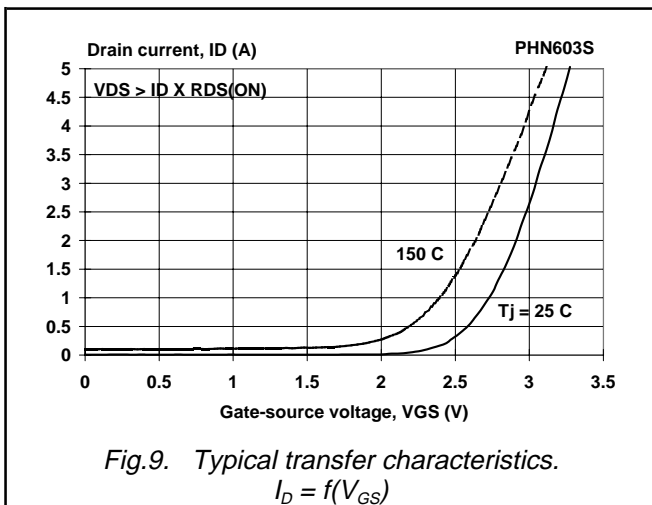
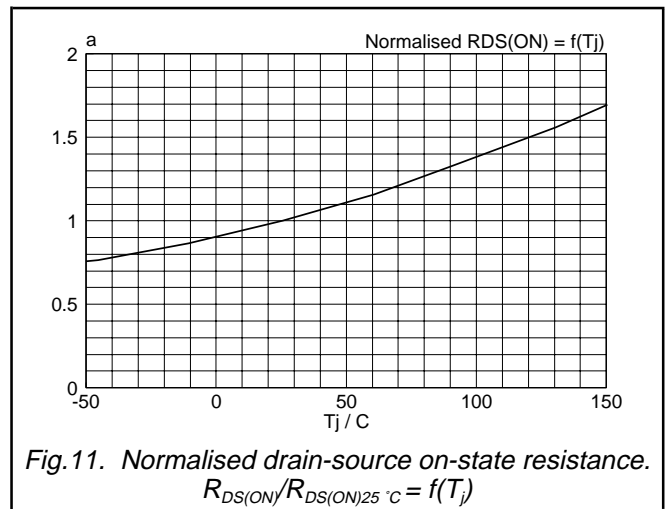
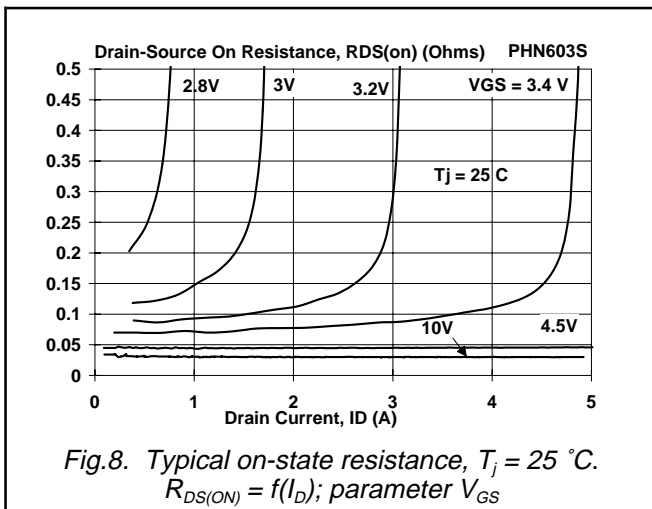
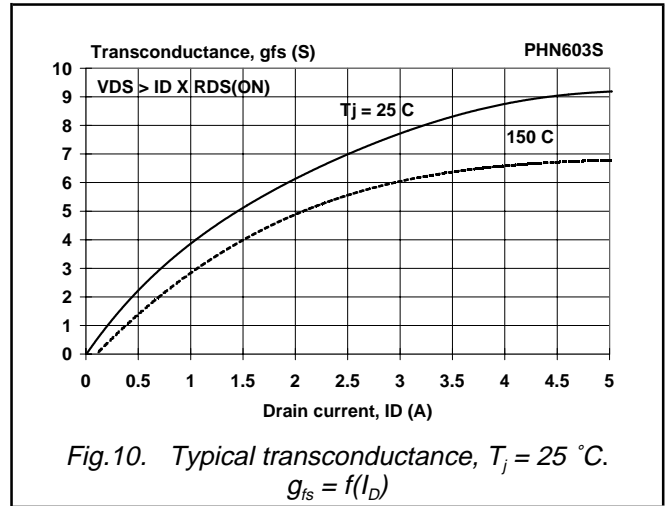
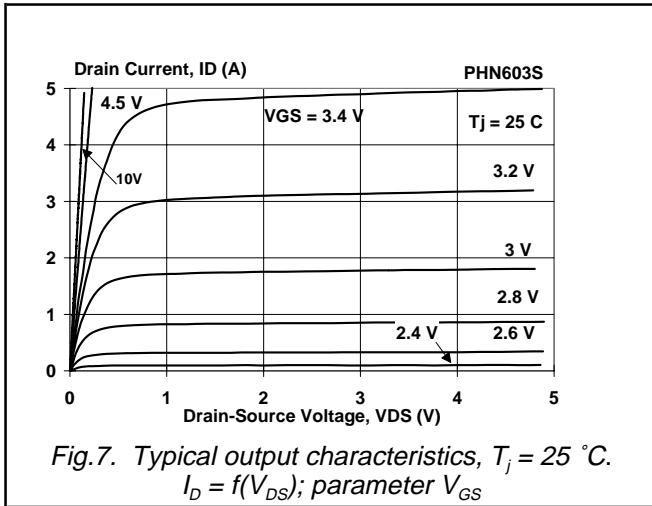

TrenchMOS/ Schottky diode array  
Three phase brushless d.c. motor driver

PHN603S

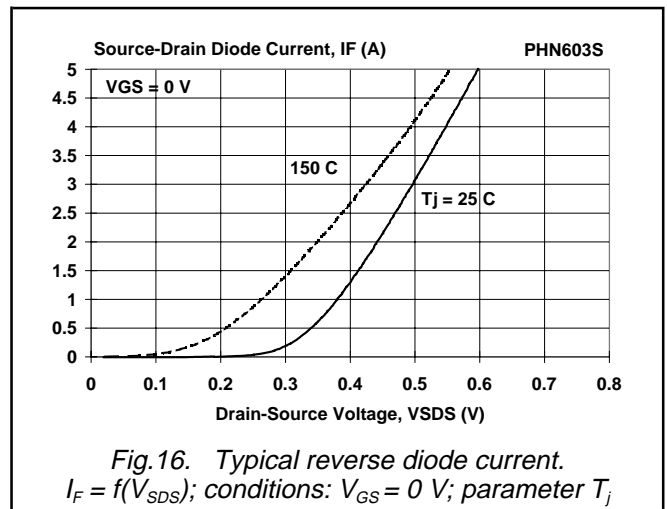
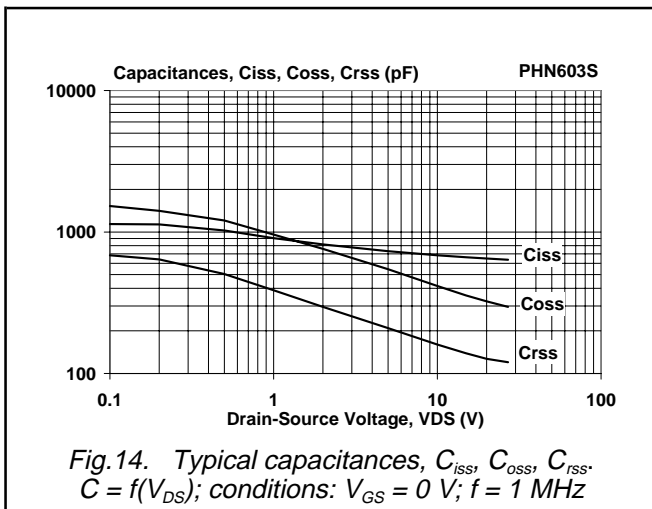
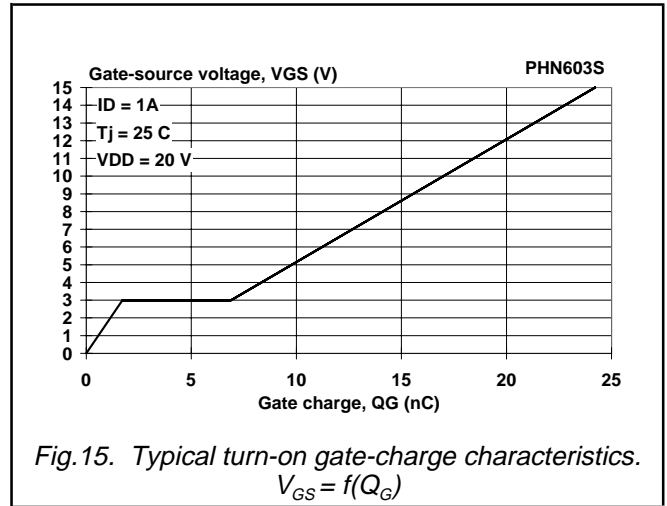
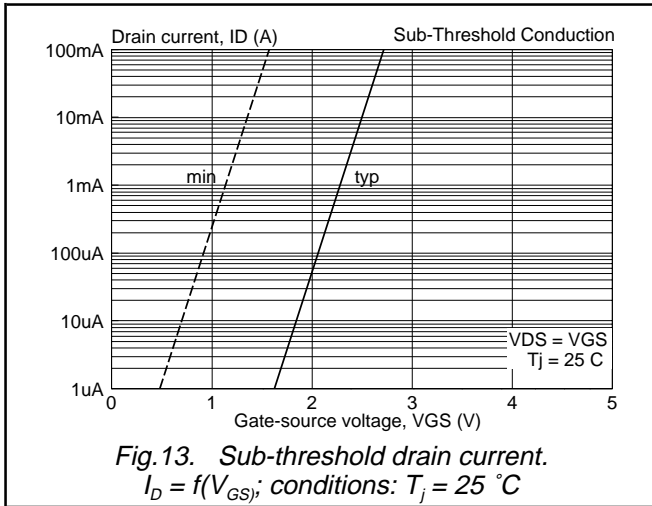

TrenchMOS/ Schottky diode array  
Three phase brushless d.c. motor driver

PHN603S

MECHANICAL DATA

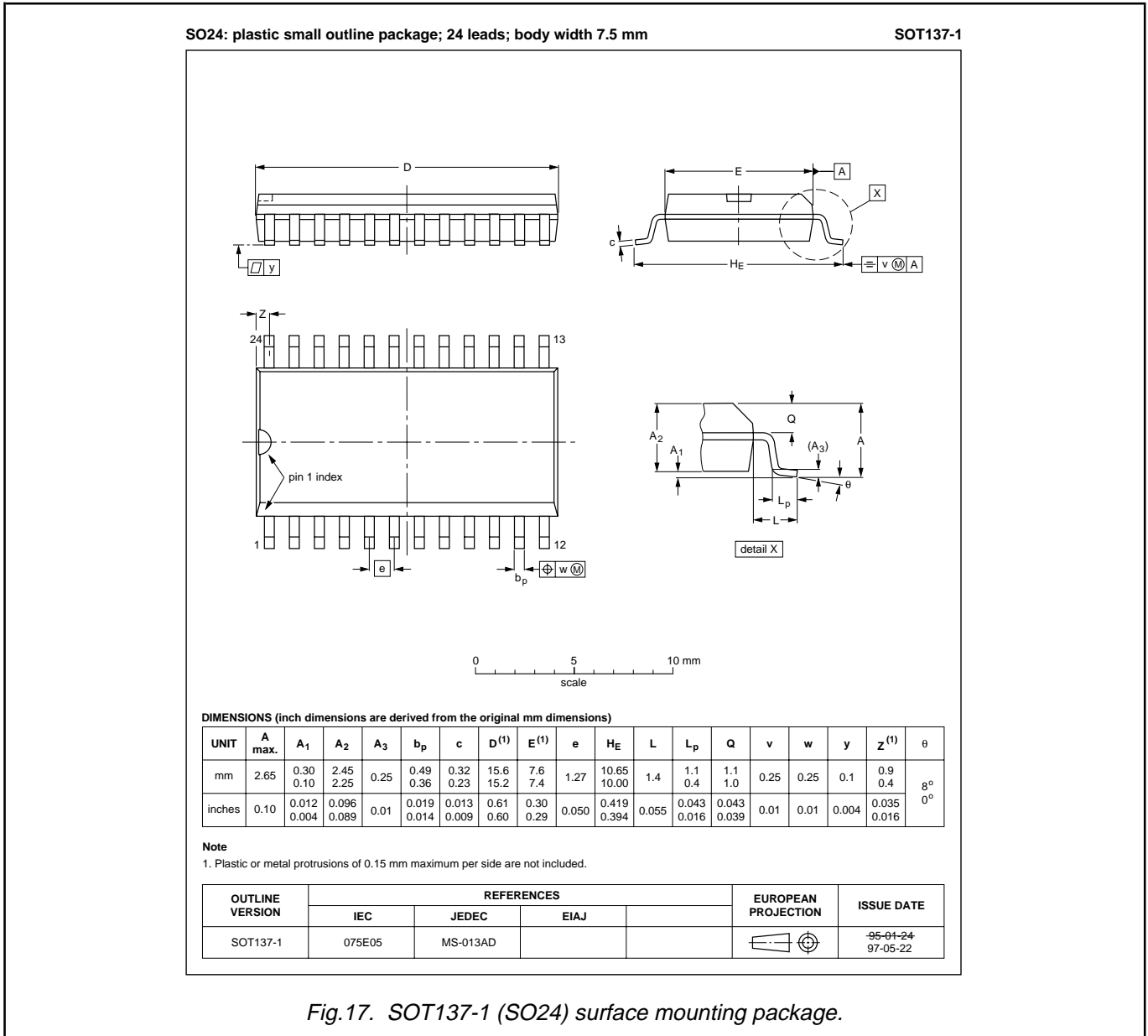

Notes

1. This product is supplied in anti-static packaging. The gate-source input must be protected against static discharge during transport or handling.
2. Refer to Integrated Circuit Packages, Data Handbook IC26.
3. Epoxy meets UL94 V0 at 1/8".

# TrenchMOS/ Schottky diode array

## Three phase brushless d.c. motor driver

PHN603S

### DEFINITIONS

<b>Data sheet status</b>	
Objective specification	This data sheet contains target or goal specifications for product development.
Preliminary specification	This data sheet contains preliminary data; supplementary data may be published later.
Product specification	This data sheet contains final product specifications.
<b>Limiting values</b>	
Limiting values are given in accordance with the Absolute Maximum Rating System (IEC 134). Stress above one or more of the limiting values may cause permanent damage to the device. These are stress ratings only and operation of the device at these or at any other conditions above those given in the Characteristics sections of this specification is not implied. Exposure to limiting values for extended periods may affect device reliability.	
<b>Application information</b>	
Where application information is given, it is advisory and does not form part of the specification.	
<b>© Philips Electronics N.V. 1998</b>	
All rights are reserved. Reproduction in whole or in part is prohibited without the prior written consent of the copyright owner.	
The information presented in this document does not form part of any quotation or contract, it is believed to be accurate and reliable and may be changed without notice. No liability will be accepted by the publisher for any consequence of its use. Publication thereof does not convey nor imply any license under patent or other industrial or intellectual property rights.	

### LIFE SUPPORT APPLICATIONS

These products are not designed for use in life support appliances, devices or systems where malfunction of these products can be reasonably expected to result in personal injury. Philips customers using or selling these products for use in such applications do so at their own risk and agree to fully indemnify Philips for any damages resulting from such improper use or sale.